

Title: EMI Reduction Clocks	MERCURY UNITED www.MercuryUnited.com	Date: Sept 1, 2017
Product: HM series		Revision: 3
TN No.: TN-020		Page 1 of 7

Title: EMI Reduction Spread Spectrum Crystal Oscillator [SSXO]

Background

Traditional ways of dealing with EMI (**E**lectronic **M**agnetic **I**nterference) problems include using EMI filters, ferrite beads, chokes, adding a power layer and a ground plane to the board, putting more metal shielding, applying a special coating and inserting RF gaskets. However, the principle sources of the EMI problem comes from the system's clocks, including frequency timing generators, crystal oscillators, VCOs and PLLs. It is obvious that the most efficient and economic way to reduce EMI from the entire system is to use a low EMI Spread Spectrum Crystal (SSXO) oscillator. The advantages of using a low EMI oscillator is to easily pass the stringent regulatory testing requirements, causing a shorter time-to-market and reducing your overall cost. A custom frequency SSXO is now available in a day with Mercury's **QuikXO™** (Quick Turn) SSXO line of products.

Spread Spectrum Technology (SST)

The maximum allowable EMI radiation normally refers to the peak EMI emissions, not the averaged emissions. A good approach is to spread out the concentrated mode energy, on one particular frequency, to a broader bandwidth and control the frequency range (for example: center frequency $\pm 1\%$) with a controlled modulation rate. The total mode energy remains the same but the peak energy is spread out to near-by frequencies. This frequency modulation technique is known as **Spread Spectrum Technology (SST)**. Instead of patching the EMI problems with filtering and shielding, the SST provides an efficient and low cost solution to expensive EMI troubles. The **Spread Spectrum Crystal Oscillator (SSXO)** takes advantage of the SST by providing a reduction in EMI at the frequency source. In most cases, system designers face EMI problems at the time that their products fail the EMI/EMC regulations test at the test lab. Mercury's new "**QHM**" EMI Reduction Clock Series is a drop-in replacement solution for situations like this. The big advantage is that there is no need to re-spin the circuit board.

As shown in the following spectrum comparison graphs, a conventional (un-modulated) clock oscillator has a narrow band width and peak radiation energy, while the SSXO shows an EMI reduction of -10 dB or more, typically. The modulation carrier frequency is usually in the range of 6 to 55 KHz (model and frequency dependent) which makes the modulation process transparent to the oscillator frequency. Consequently, the electronic device perform with lower EMI emissions, showing no affect by the resultant instantaneous frequencies.

Center Spread vs. Down Spread

The controlled modulation process can be entirely on one side of the nominal frequency (this is called a **down spread**) or 50% up and 50% down (this is called a **center spread**). Using a 100 MHz SSXO as an example, the center frequency modulates between 99.500 MHz and 100.500 MHz with a center spread of $\pm 0.5\%$. The frequency range modulates between 99.500 MHz and 100.0 MHz with a down spread of -0.25%. By moving the center frequency, a down spread -0.5% modulation can be considered a process equivalent to a center spread of $\pm 0.25\%$. In another words, a modulation between 99.500 MHz and 100.0 MHz (down -0.5%) is equivalent to center spread of $\pm 0.25\%$ with the center frequency being 99.750 MHz.

		Instantaneous Frequencies (min.)	Center Frequency	Instantaneous Frequencies (max.)
A.	100 MHz at center spread $\pm 0.5\%$	99.500 MHz	100.000 MHz	100.500 MHz
B.	100 MHz at down spread - 0.5%	99.500 MHz		100.000 MHz
	"B" is equivalent to 99.750 MHz at a center spread of $\pm 0.25\%$	99.500 MHz	99.750 MHz	100.000 MHz



Title: EMI Reduction Clocks	MERCURY UNITED www.MercuryUnited.com	Date: Sept 1, 2017
Product: HM series		Revision: 3
TN No.: TN-020		Page 2 of 7

The down spread is recommended if a system cannot tolerate an operating frequency higher than the nominal frequency, also known as over-clocking. In the 100 MHz center spread $\pm 0.5\%$ example above, there is a period of time where the system runs between 100.000 MHz and 100.500 MHz. These instantaneous frequencies are higher than the system clock and may erode the system's timing margin. Using a down spread SSXO can avoid this over-clocking problem with the sacrifice of a slightly slower clock rate.

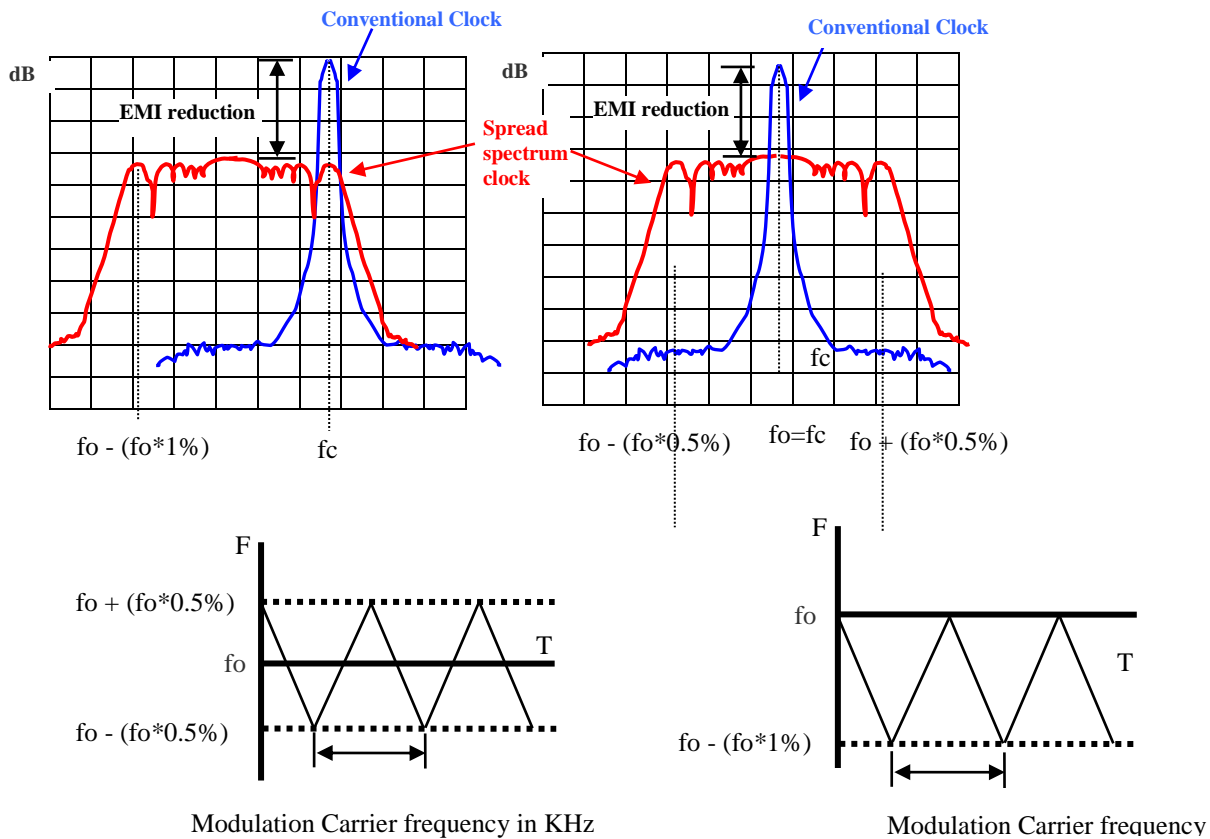

Figure 1: Spectrum comparisons of a -1% down spread and a $\pm 0.5\%$ center spread

Modulation Carrier Frequency:

The modulation carrier frequency, or sweep rate, is usually in the KHz frequency range, which is relatively slower than the MHz frequency range of the clock oscillator. As shown in figure 1, the output frequency is slowly swept within the pseudo triangle shape wave envelope from the f (max) to fo (nominal), then to f (min) then to fo (nominal), and back and forth. The resultant instantaneous frequencies are always between f (max) and f (min). The modulation percentage determines the bandwidth of the span while the modulation carrier frequency determines the spacing of the spectral.

Title: EMI Reduction Clocks	MERCURY UNITED www.MercuryUnited.com	Date: Sept 1, 2017
Product: HM series		Revision: 3
TN No.: TN-020		Page 3 of 7

EMI Reduction at the Harmonics:

As shown in figure 2 and figure 3 below, the higher order harmonic frequencies do get a stronger EMI reduction. They also show a greater modulation percentage that reduces EMI emissions more. It needs to be pointed out that the fundamental frequency, as well as every harmonic, will receives an EMI reduction by the SSXO.

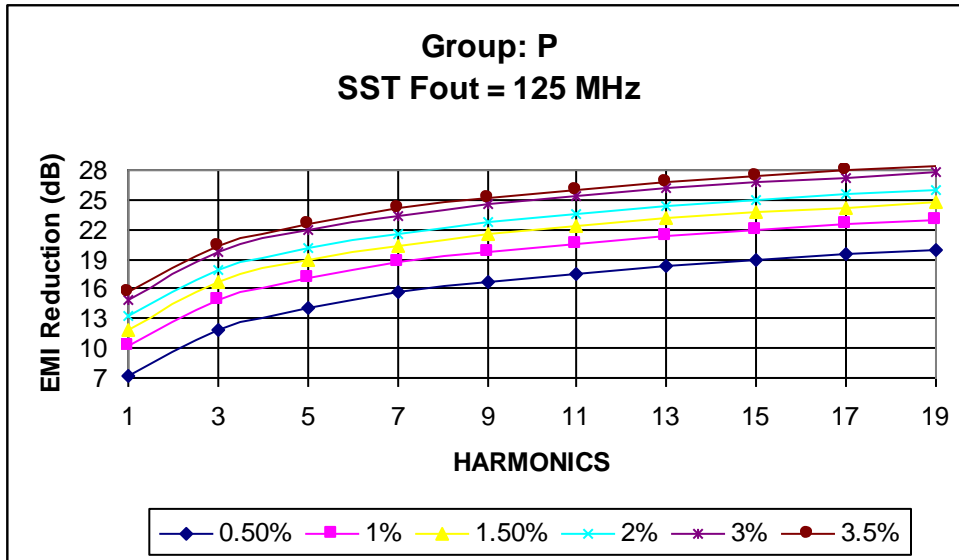

Figure 2: EMI reduction at harmonics for Mercury HM series group P

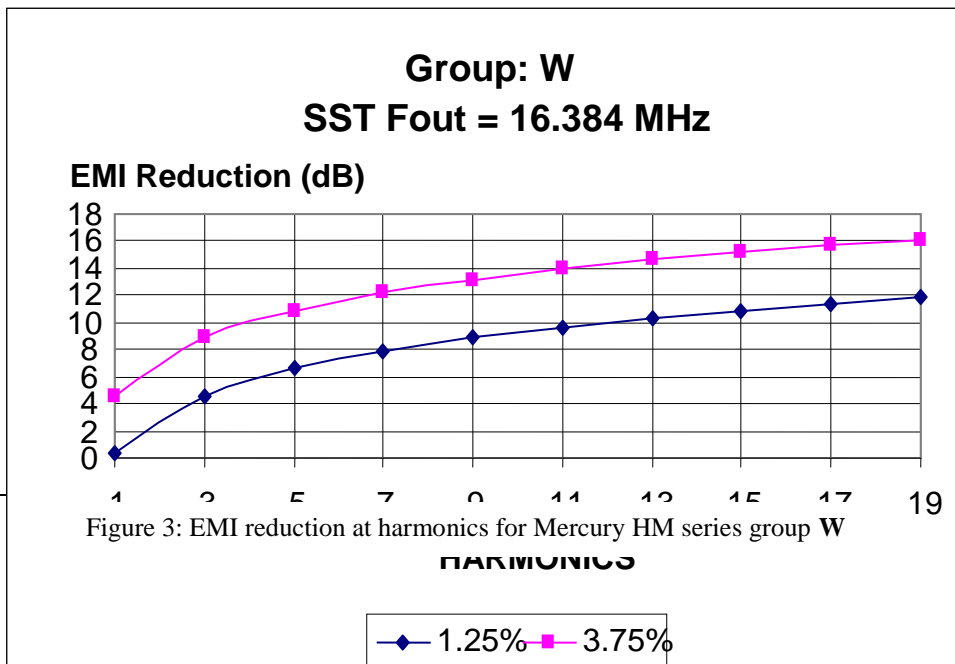

Figure 3: EMI reduction at harmonics for Mercury HM series group W



Title: EMI Reduction Clocks	MERCURY UNITED www.MercuryUnited.com	Date: Sept 1, 2017
Product: HM series		Revision: 3
TN No.: TN-020		Page 4 of 7

Measurement Data:

The EMI reduction data shown below is actual measurement data taken from a Mercury 3HM57 Group “R” 100MHz SSXO at various spread percentages and harmonics.

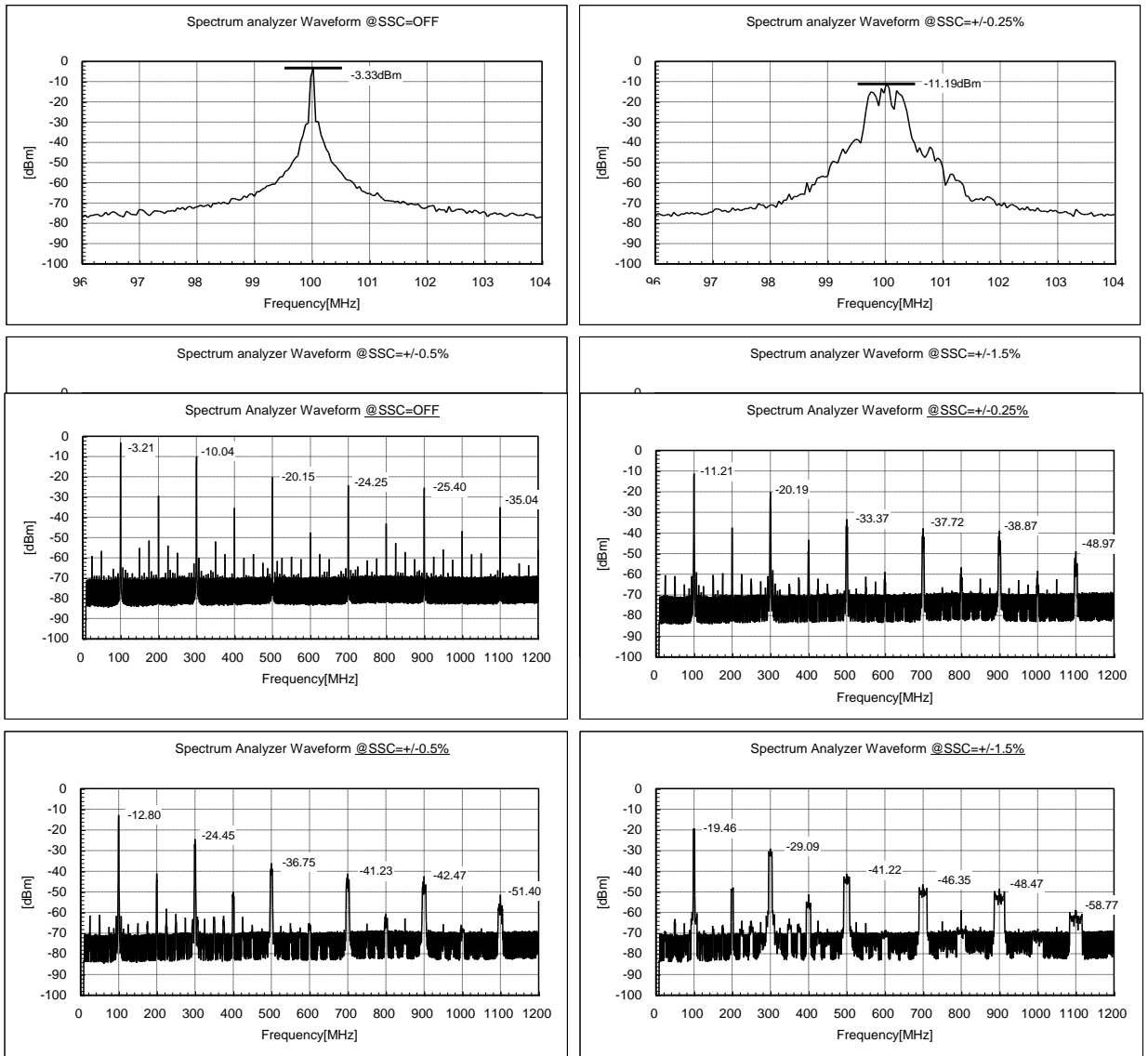

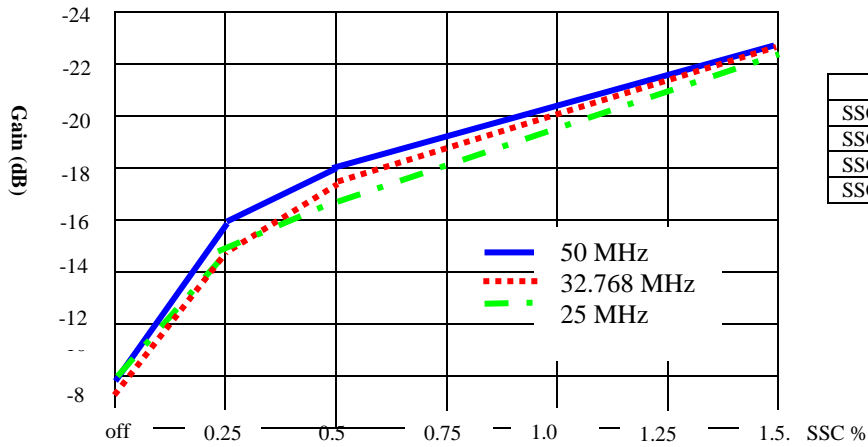

	25 MHz	32.768 MHz	50 MHz
SSC is off	-10.1 dB	-9.9 dB	-10.1 dB
SSC=±0.25%	-15.5 dB	-15.6 dB	-16.3 dB
SSC=±0.5%	-17.6 dB	-17.8 dB	-18.2 dB
SSC=±1.5%	-22.9 dB	-23.0 dB	-23.3 dB

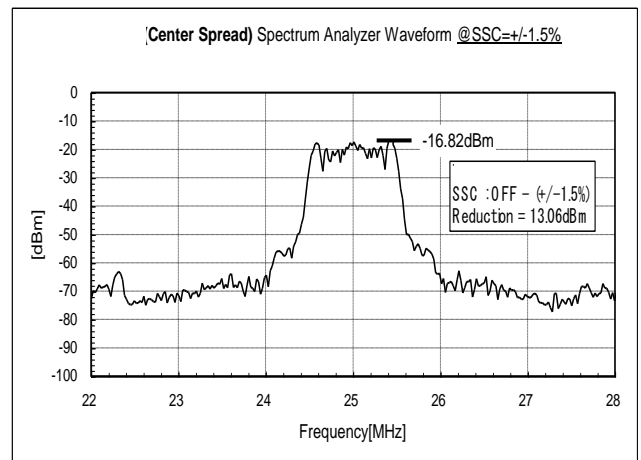
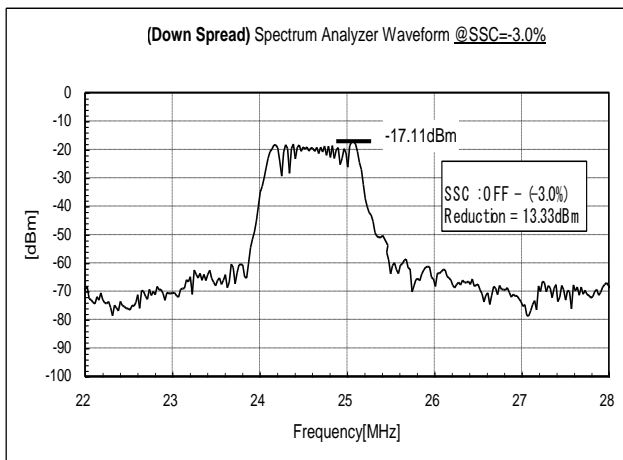
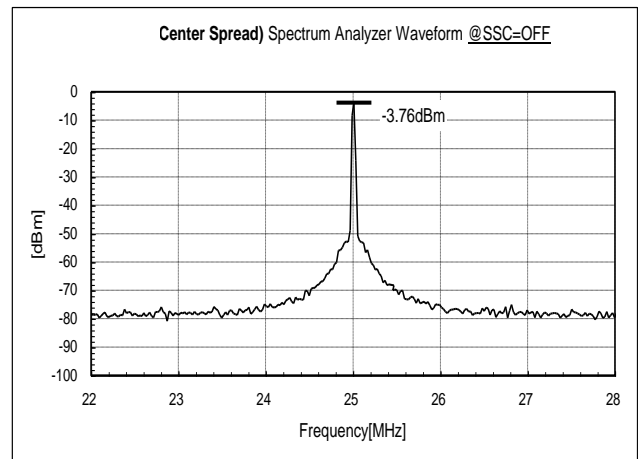
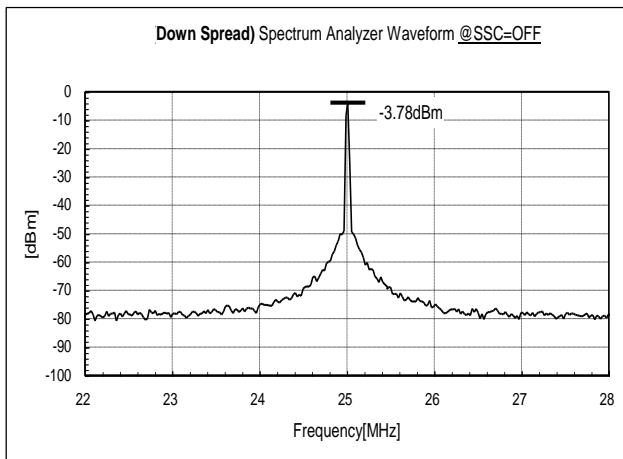

25 MHz at down spread -3% and center spread ±1.5%. The EMI reduction is about the same.



Title: EMI Reduction Clocks	MERCURY UNITED www.MercuryUnited.com	Date: Sept 1, 2017
Product: HM series		Revision: 3
TN No.: TN-020		Page 6 of 7

	Start-up Time (u. sec.)	Current Consumption (mA)	Tr Rise Time (n. sec.)	Tf Fall Time (n. sec.)	Duty Cycle (%)	Logic "1"	Logic "0"
SSC=OFF	200	3.1	1.9	2.0	48.4	3.40	0.14
	290	3.0	2.1	2.3	48.5	3.31	0.25
	200	3.0	1.9	2.5	48.6	3.39	0.16
Center Spread ±0.25%	780	8.4	2.2	2.5	49.1	3.31	0.14
	780	8.1	2.8	2.3	50.0	3.23	0.18
	880	8.3	2.3	2.1	48.9	3.30	0.15
Center Spread ±0.5%	880	8.4	2.4	1.5	49.4	3.16	0.25
	780	8.5	2.6	2.3	49.5	3.32	0.06
	880	8.5	2.7	2.1	49.2	3.36	0.11
Center Spread ±1.5%	780	8.9	1.4	1.0	48.6	3.19	0.14
	880	8.7	1.7	1.0	49.1	3.16	0.14
	980	8.5	2.1	0.5	49.1	3.40	0.14

+3.3V, 25.000 MHz, group "R" oscillator parameter comparisons, Ta=25°C, CL=15 pF

SSXO Block Diagram:

The spread spectrum technology can be simplified and expressed as follows:

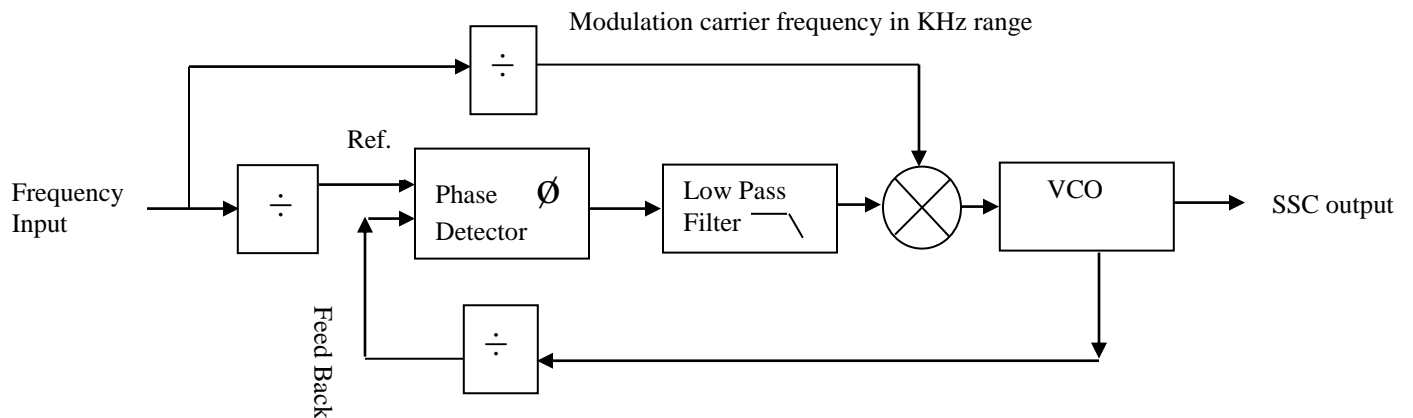

Title: EMI Reduction Clocks	MERCURY UNITED www.MercuryUnited.com	Date: Sept 1, 2017
Product: HM series		Revision: 3
TN No.: TN-020		Page 7 of 7

Jitter Due to Frequency Modulation:

Although the SST modulation is processed in the background and the modulation carrier frequency is at least one thousand times slower than the nominal frequency, one concern still remains, the amount of jitter contributed to the whole system due to the instantaneous frequency. A comparison between clocks with and without the SST modulation shows that the modulation process contributes less than +0.05% of the cycle-to-cycle jitter to the system. This negligible jitter contribution has made the spread spectrum crystal oscillator become more popularity with many different applications.

Mercury's **QuikXO™** (One Day Quick Turn) "QHM" and "HM Group P" SSXO Series has a maximum cycle-to-cycle jitter of only ± 100 ps, while Mercury's "HM Group R" SSXO Series has a maximum cycle-to-cycle jitter of ± 300 ps.

Concerns with using a SSXO in a PLL Circuit

Most PLL circuits can work with a SSXO without having any timing problems. However, a downstream PLL circuit (defined as a PLL circuit that receives a clock signal from another PLL in the circuit) requires extra precaution in terms of tracking skew. There are PLL circuits, or zero delay buffers, available in the market specifically designed to work with spread spectrum crystal oscillators.

Another area to be concerned with is the tracking rate. The PLL circuit needs to be faster than the modulation rate of the SSXO. All Mercury SSXO Series have modulation carrier frequencies below 60 KHz. A downstream PLL circuit with a 6 μ s tracking capability will work fine.

Power Supply to the SSXO

Power supply filtering plays an important role to the EMI reduction and optimum jitter performance of the system. The circuit below shows the recommended power supply filtering configuration. This lowpass "PI (PI)" filter can remove power supply noise and prevent clock noise from feeding back to the supply. A low frequency supply decoupling tantalum capacitor at 22 μ F is recommended at C₁. A high frequency 0.1 μ F ceramic chip supply decoupling capacitor is recommended at C₂. While at C₃, a decoupling capacitor for the SSXO, can be a 0.1 μ F ceramic chip capacitor. If ferrite bead, C₁ and C₂ are not available, a tantalum type capacitor is preferred for C₃. All capacitors should be placed as close to the SSXO as possible, otherwise the increased trace inductance will negate its decoupling capability.

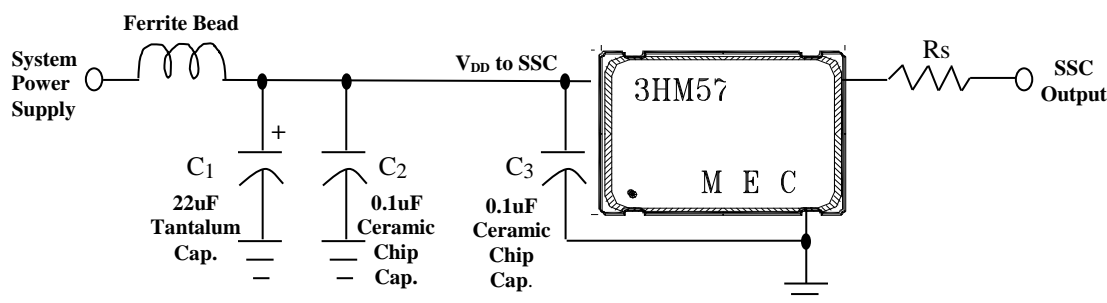

Series Termination Resistor (Rs)

The SSXO output traces over one inch should use a series termination. The SSXO output impedance is typically 30 ohms. Therefore, for a 50 ohm trace impedance board, a 22 ohm chip resistor is recommended. 47 ohm is recommended for a 75 ohm trace impedance board. The series resistor should be placed in series with the clock line and as close to the SSXO output pin as possible. The series resistor helps to maintain the signal integrity and enhances the EMI emissions reduction.

